

**High Rate Information Transmission
Emergency Managers Weather Information
Network (HRIT/EMWIN) User Group**

Quarterly Meeting

13 September 2018

Agenda Items & Schedule

- 3:00 pm (EST) – Roll Call/ Introduction to User Group-----Seth Clevenstine – 5 mins
- GOES East/West Status-----Seth Clevenstine – 5 mins
- GOES-17 ABI Status and GOES West Transition Plans-----Seth Clevenstine – 5 mins
- HRIT/EMWIN GOES East Product Status-----Seth Clevenstine – 5 mins
- Broadcast Issues Observed in Past 3 Months----- Seth Clevenstine – 5 mins
- Planned Broadcast Imagery Configurations-----Seth Clevenstine – 10 mins
- GOES-R Baseline Level II Products Update-----Seth Clevenstine – 5 mins
- GOES-17 Post Launch Testing and User Input-----Seth Clevenstine – 5 mins
- EMWIN update-----Bob Gillespie – 5 mins
- Open Discussion Items-----Open – 20 mins
- Action items and summary-----Paul Seymour – 5 mins
- Total – 65 mins

Purpose of the User Group

- Form a User Community for HRIT/EMWIN
- Provide the latest news on the HRIT/EMWIN broadcast
- Provide the latest status on the GOES-17 Schedule
- Information Exchange on Broadcast Content
- Updates on User / Manufacturer Readiness
- Other Topics As They Arise

HRIT/EMWIN User Group

-GOES East/West Operational Status

-GOES-17 ABI Status and Transition Plans

Seth Clevenstine

Current Status of GOES-15 and GOES-16

- GOES-16 is GOES-East at 75.2° West as of 12/18/2017
 - HRIT/EMWIN is operational on GOES-East
 - A 1692.7 MHz EMWIN broadcast is active on GOES-14 at 105° West and extended until November 15, 2018
 - LRIT & EMWIN broadcasts are still operational on GOES-15 (West)

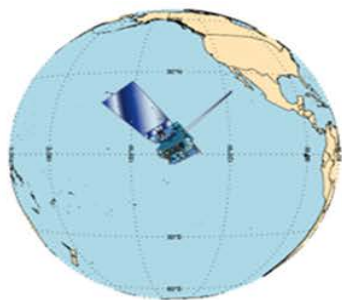

GOES West
GOES-15
 135° West



Standby
GOES-14
 105° West



Checkout
GOES-17
 89.5° West



GOES East
GOES-16
 75.2° West



Storage
GOES-13
 60° West

Future GOES Constellation (West Transition)

GOES-West
GOES-15
135° West

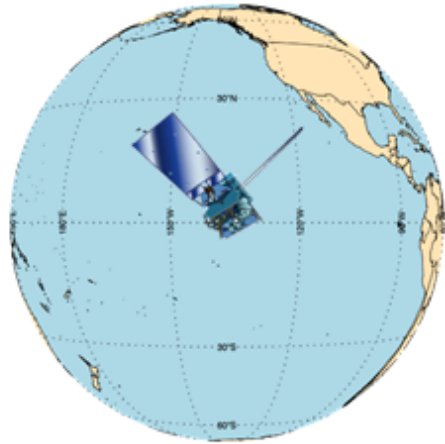

Standby
GOES-14
105° West

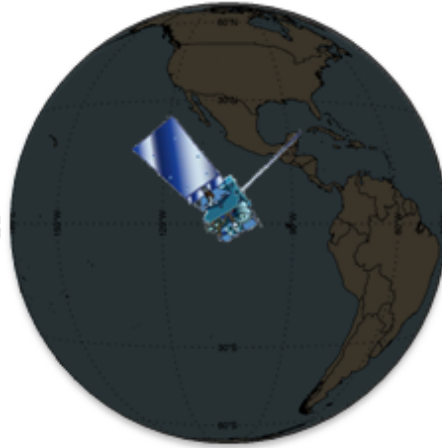

GOES-East
GOES-16
75.2° West

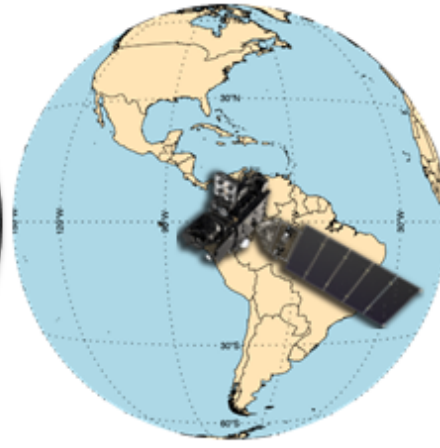

Storage
GOES-13
60° West

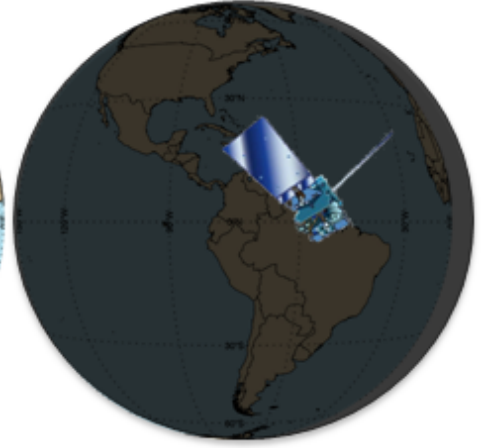

GOES-West
GOES-S
137° West

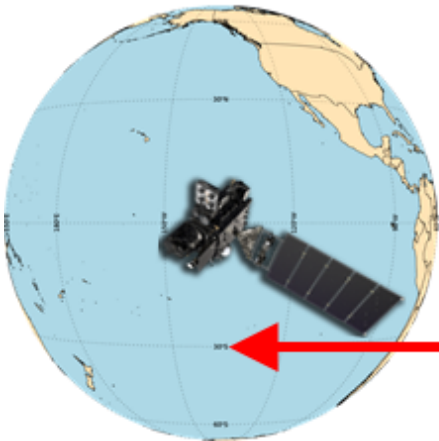

Checkout
GOES-S
89.5° West



Information on GOES-15's location during transition is TBD

Future GOES Constellation (Post Transition)

Current Constellation as of September 2018



Future Constellation (TBD)

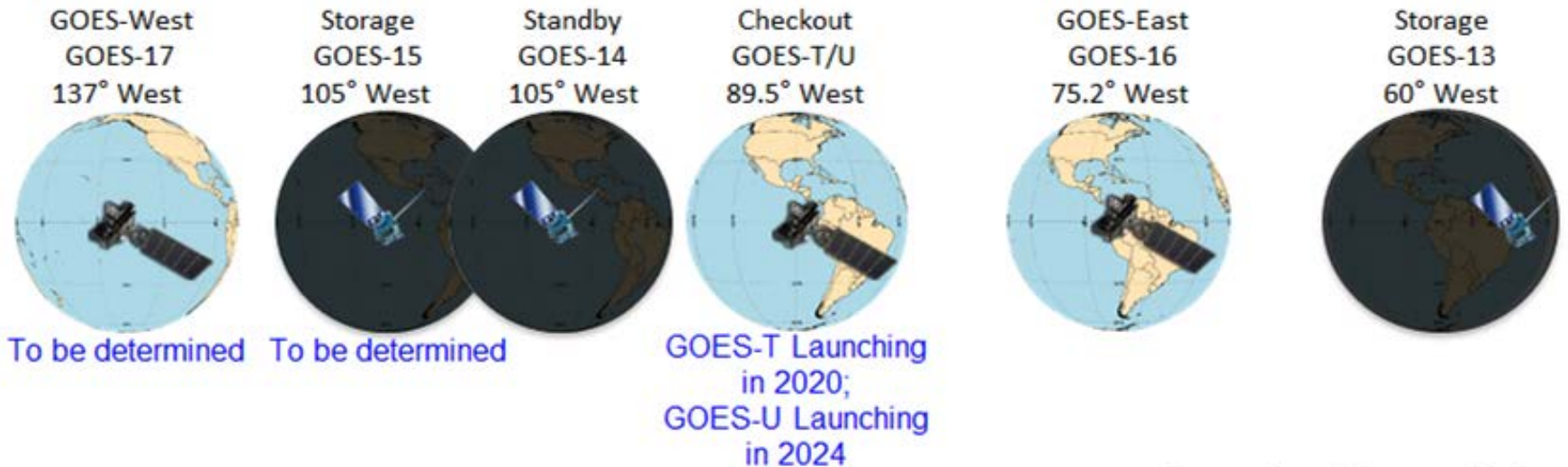

May 2018 GOES East HRIT Statistics

May Total Broadcast Bandwidth %

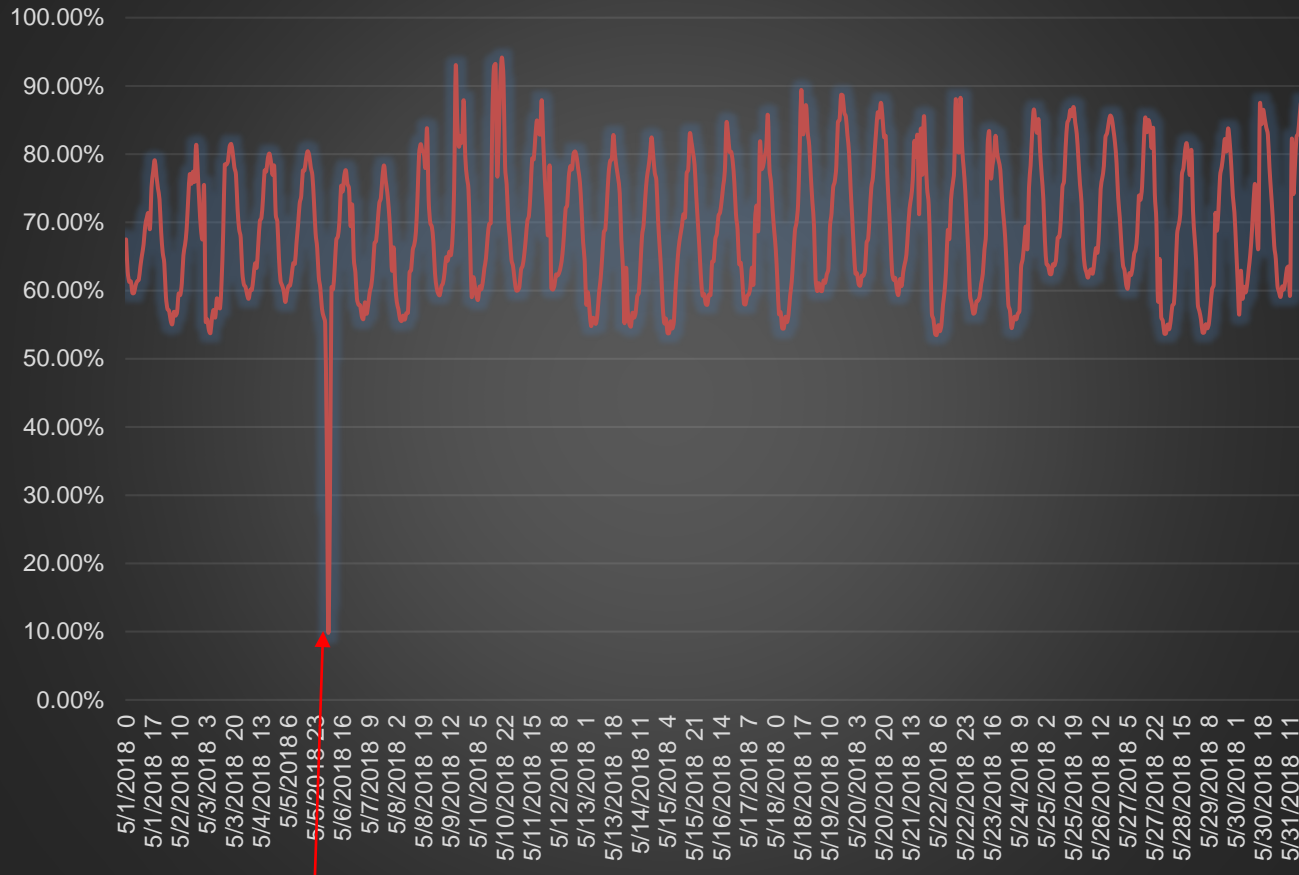

Planned 2 hour GOES-16 to PDA Outage

Monthly Averages

18Z Daytime Peak %	82.4%
Imagery Group	75.7%
DCS	3.8%
EMWIN	2.9%
04Z Night time Lull %	57.6%
Imagery Group	50.8%
DCS	3.8%
EMWIN	2.9%
Daily Total Data Size	23.9 GB



June 2018 GOES East HRIT Statistics

June Total Broadcast Bandwidth %

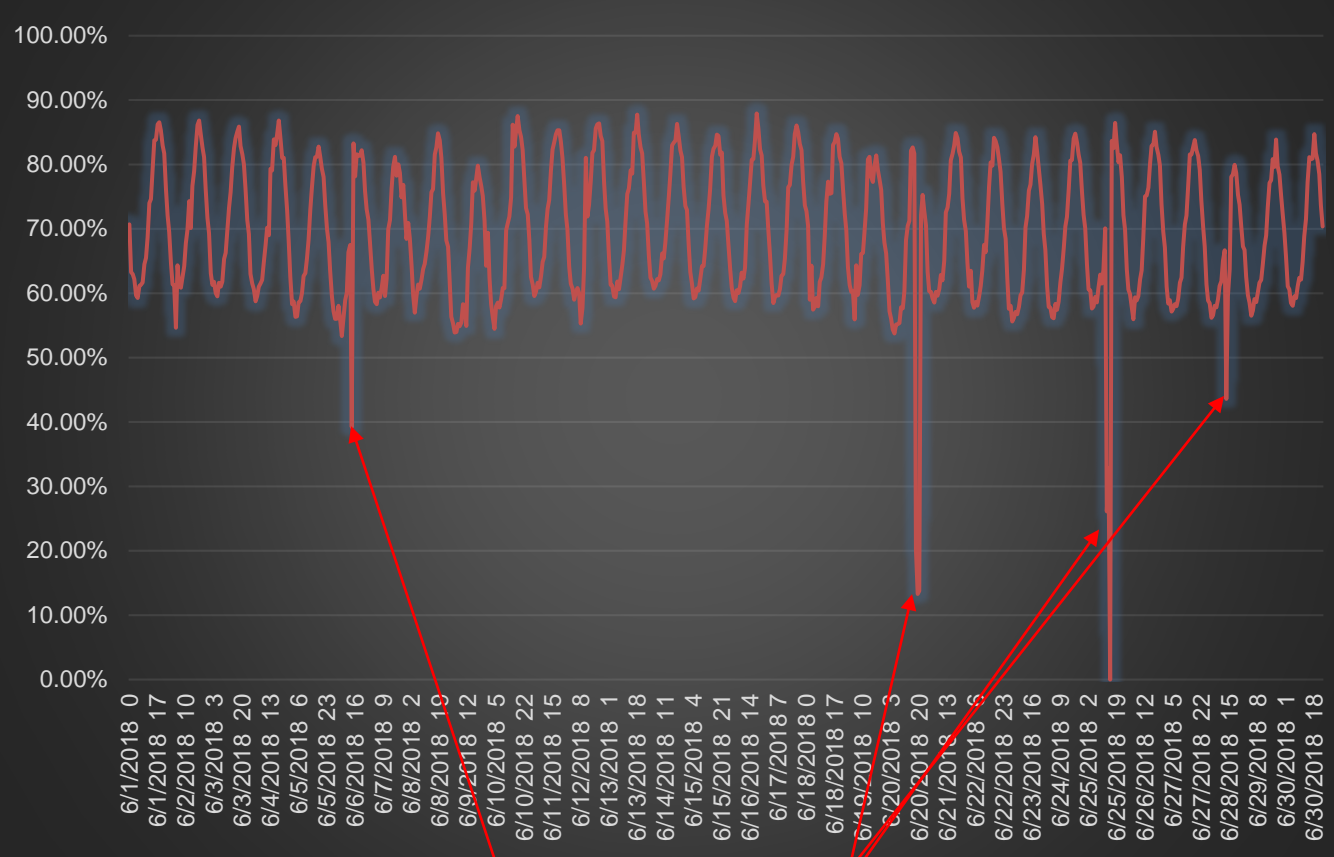

PDA Anomalies

Monthly Averages

18Z Daytime Peak %	82.8%
Imagery Group	75.1%
DCS	3.9%
EMWIN	3.9%
04Z Night time Lull%	57.7%
Imagery Group	50.1%
DCS	3.9%
EMWIN	3.8%
Daily Total Data Size	24.0 GB

July 2018 GOES East HRIT Statistics

July Total Broadcast Bandwidth %

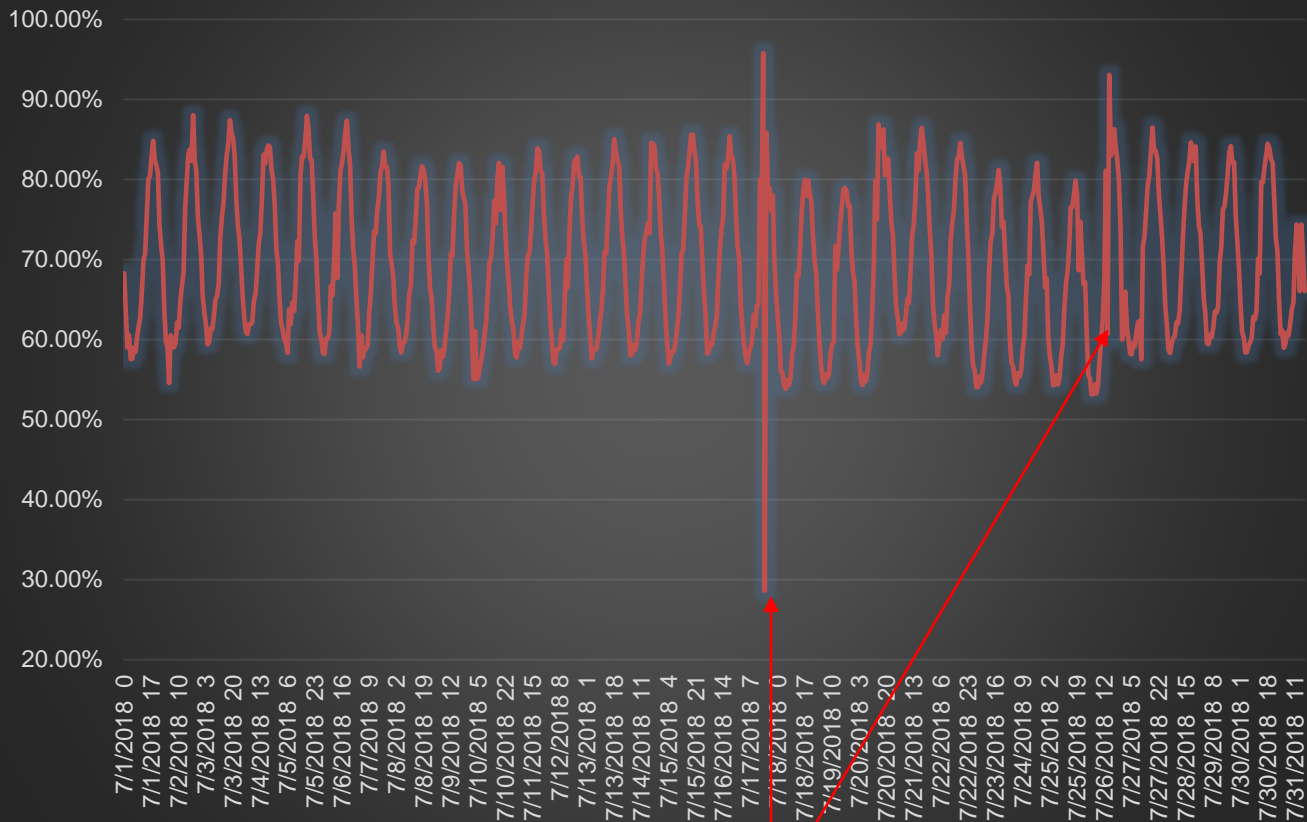

PDA Queue Backlog Anomalies

Monthly Averages

18Z Daytime Peak %	83.7%
Imagery Group	76.0%
DCS	3.9%
EMWIN	3.8%
04Z Night time Lull%	57.3%
Imagery Group	50.0%
DCS	3.9%
EMWIN	3.5%
Daily Total Data Size	24.0 GB



GOES-17 ABI Status Update August 8, 2018

Dan Lindsey (NESDIS)
Joe Pica (NWS)
Kevin Schrab (NWS)





Loop Heat Pipe Anomaly

- Loop Heat Pipes on G-17 ABI not functioning properly
- During nighttime hours, the sun heats up the ABI detectors faster than we can cool them
- Detectors become warmer than they're designed to operate, and they begin to radiate at temperatures closer to the wavelengths they're attempting to detect from the Earth
- Eventually, local emission and dark current noise overwhelm the signal from the Earth, and the channels saturate, meaning there's no useful signal at all
- The longer wavelengths, i.e., the IR channels, are generally affected first, and the shorter wavelengths (VIS and near-IR) not at all



GOES-17 ABI Anomaly Teams



Root Cause Team: Determine why Loop Heat Pipes aren't working and attempt to fix on GOES-T and -U

Mission Recovery & Mitigation Team:

- **ABI Optimization:** Determine best operating conditions (temperatures, integration times, biases, gains) of ABI to maximize data availability at acceptable quality levels
- **Constellation Options:** Investigate various combinations of available satellites to cover the GOES-West domain
- **Science Options:** Given information from Optimization and Constellation Teams, determine best operating options for NWS operations and assess resulting availability and quality of the bands and L2 products

Communications Team: Provide external notification to stakeholders, the media, and the public on the findings



Seasonal Dependence

- When GOES-17 is in the “upright” position, the solar load is minimized in the NH summer and maximized in the NH winter
- This means we can perform a yaw flip around each equinox to cut down on the seasonal solar load
- With the yaw flip strategy, the maximum solar load now occurs near equinox, except offset a few weeks on either side of equinox due to the Earth eclipsing the sun for several weeks during some of the nighttime hours



Seasonal Dependence

Sun Angle (Declination) at Local Midnight For Each Day of 2018

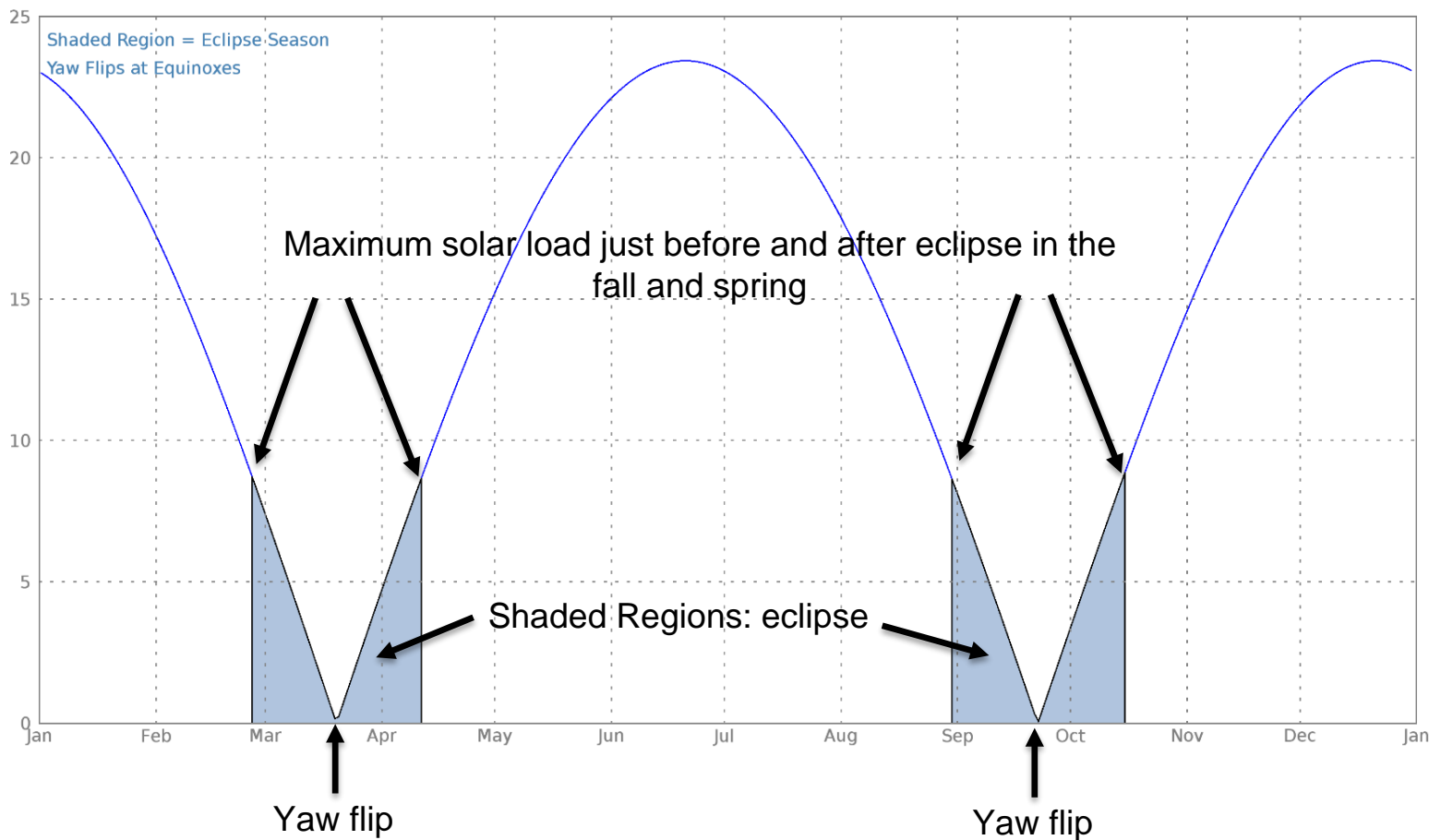

Lower angles generally mean larger solar load, except for the shaded eclipse times where the Earth blocking the sun provides for nighttime cooling



Current Assessment of Channel Availability (27 July 2018)



Band	Channel	Function	Estimated Unsaturated Signal Cold Season (Solstice)	Estimated Unsaturated Signal Warm Season (Pre-Eclipse)
1	0.47 μm	Blue	24 hr	24 hr
2	0.64 μm	Red	24 hr	24 hr
3	0.86 μm	Veggie	24 hr	24 hr
4	1.38 μm	Cirrus	24 hr	24 hr
5	1.61 μm	Snow/Ice	24 hr	24 hr
6	2.25 μm	Cloud Particle Size	24 hr	24 hr
7	3.90 μm	Shortwave Window	24 hr	24 hr
8	6.18 μm	Upper-Level Water Vapor	24 hr	18 - 20 hr
9	6.95 μm	Mid-Level Water Vapor	24 hr	18 - 20 hr
10	7.34 μm	Lower-Level Water Vapor	24 hr	18 - 20 hr
11	8.50 μm	Cloud-Top Phase	24 hr	21 hr
12	9.61 μm	Ozone	24 hr	18 - 20 hr
13	10.35 μm	Clean IR Longwave Window	24 hr	21 hr
14	11.20 μm	IR Longwave Window	24 hr	22 hr
15	12.30 μm	Dirty Longwave Window	24 hr	21 hr
16	13.30 μm	CO ₂ Longwave Infrared	24 hr	18 - 20 hr

NOTE: **Preliminary estimate** of channel availability at best/worst season; subject to change.



GOES-17 – 29 July 2018 – 0932 UTC

Time of maximum detector temperatures

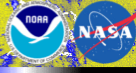
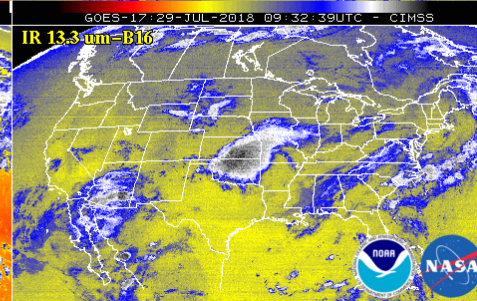
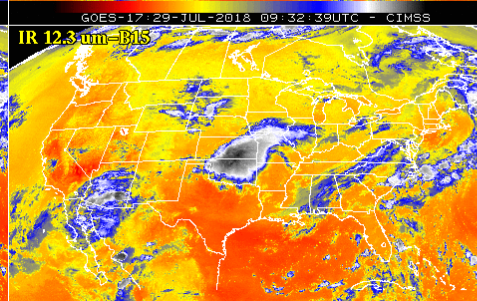
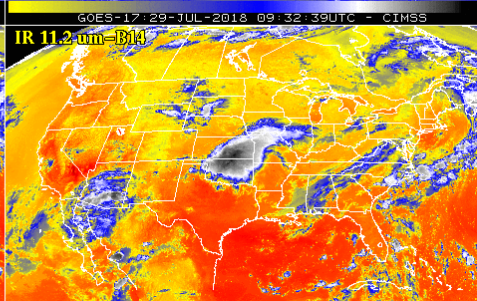
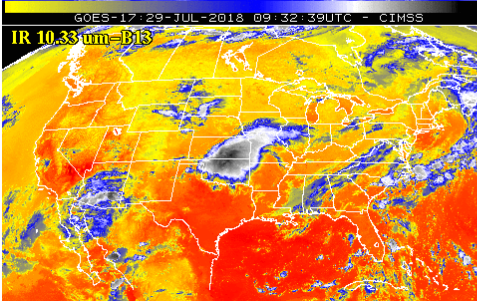
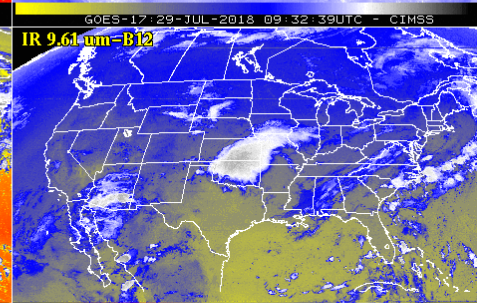
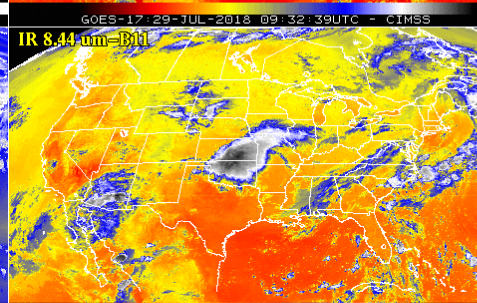
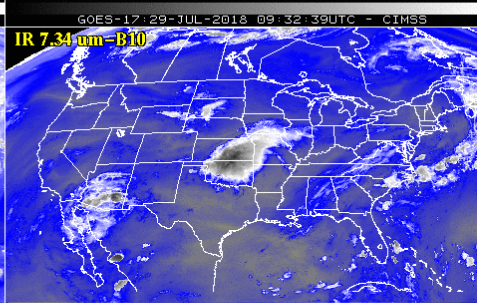
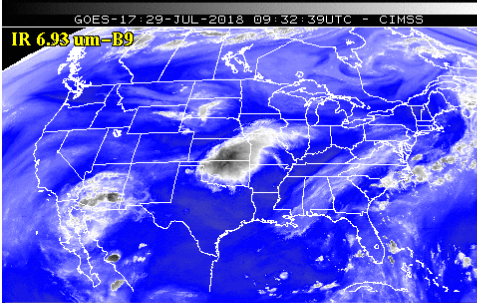
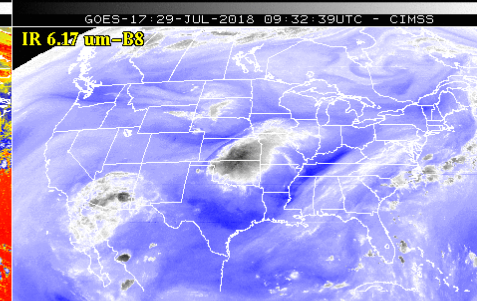
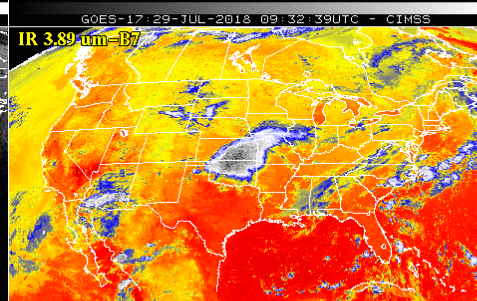
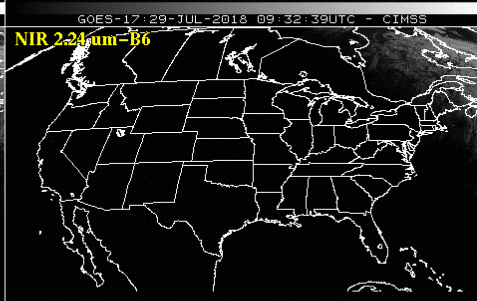
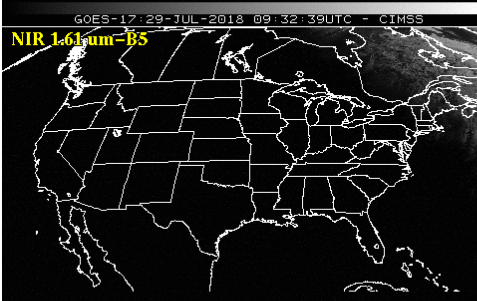
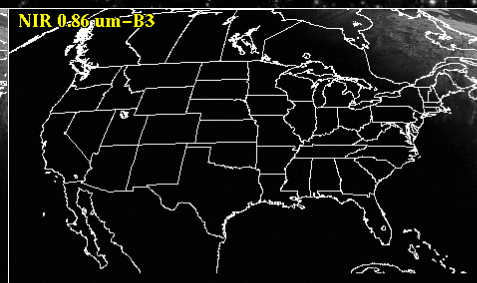
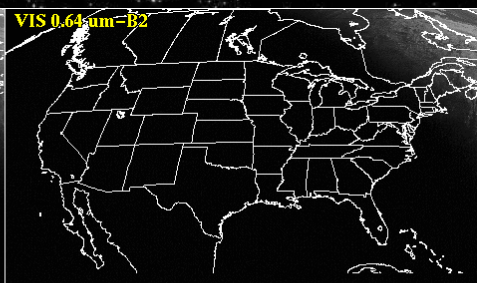
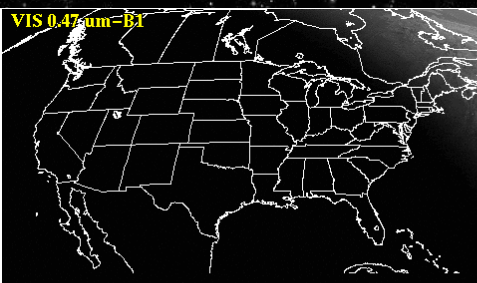



GOES-17 – 29 July 2018 – 1802 UTC

Time of “cool” detectors

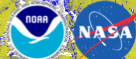
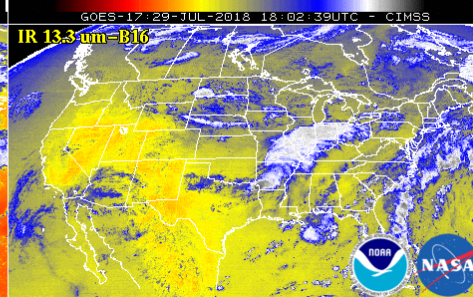
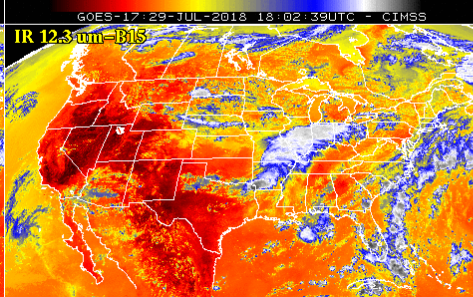
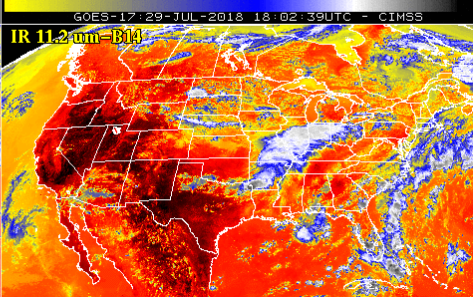
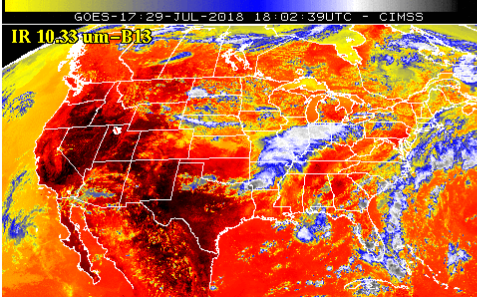
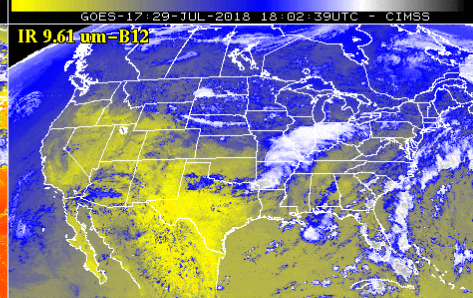
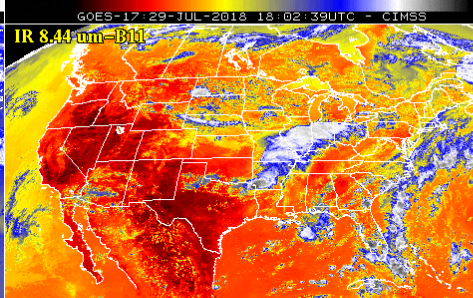
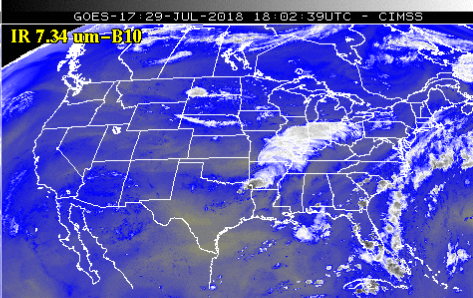
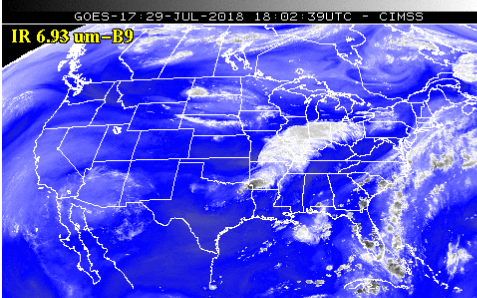
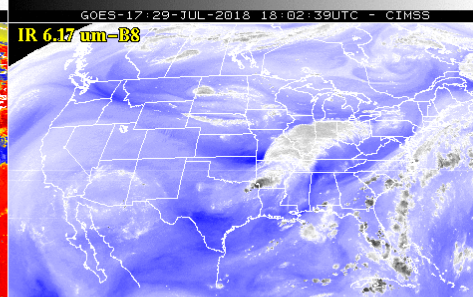
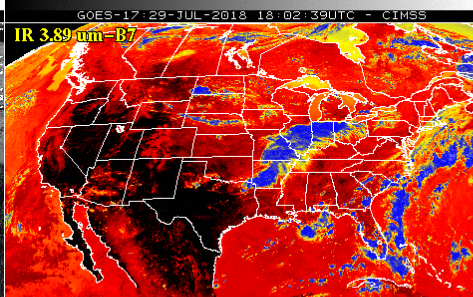
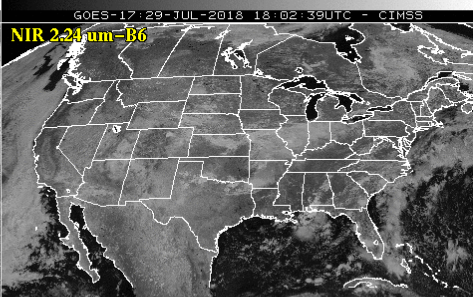
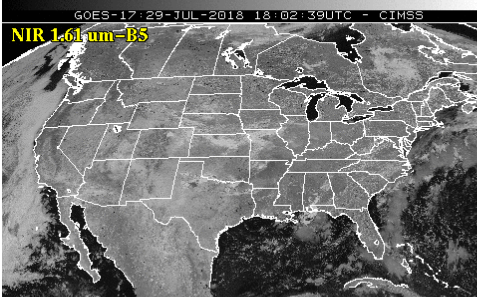
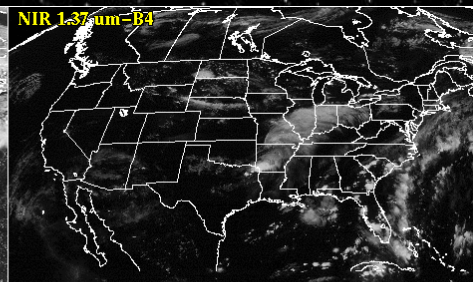
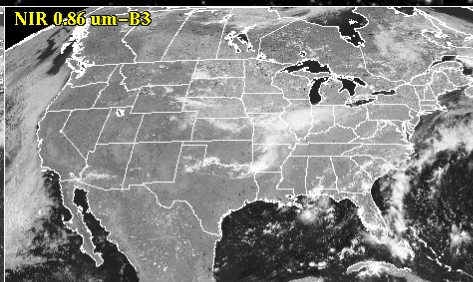
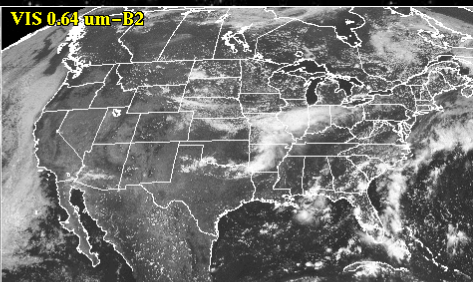
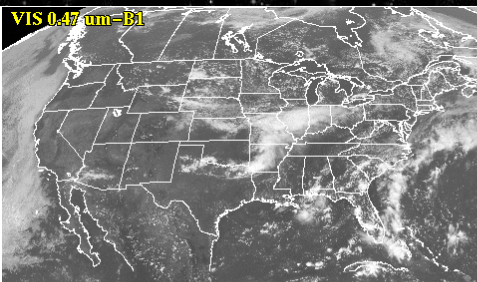



GOES-R Series Derived Products



The Science Options Team is evaluating derived products based on channel availability and data quality in order to maximize mission effectiveness.

Wavelength (Micrometers)		0.47	0.64	0.865	1.378	1.61	2.25	3.9	6.185	6.95	7.34	8.5	9.61	10.35	11.2	12.3	13.3
Channel ID		1	2	3	4	5	6	7	8	9	10	11	12	13	14	15	16
Baseline Products	Lev 1 Reqmts Doc Priority																
Cloud & Moisture Imagery	1 (KPP)	X	X	X	X	X	X	X	X	X	X	X	X	X	X	X	X
Aerosol Detection	1	X	X	X	X	X	X	X							X	X	
Aerosol Optical Depth	1	X	X	X		X	X								X		
Clear Sky Masks	1		X	X	X	X		X		X	X	X			X	X	
Cloud Optical Depth	1		X				X	X							X	X	
Cloud Particle Size Dist.	1		X				X	X							X	X	
Cloud Top Phase	1										X	X			X	X	
Cloud Top Height	1														X	X	X
Cloud Top Pressure	1														X	X	X
Cloud Top Temperature	1														X	X	X
Legacy Vertical Moisture Profile	1								X	X	X	X	X	X	X	X	X
Legacy Vertical Temp Profile	1								X	X	X	X	X	X	X	X	X
Total Precipitable Water	1								X	X	X	X	X	X	X	X	X
Derived Motion Winds	1		X					X	X	X	X				X		
Radiances	1	X	X	X	X	X	X	X	X	X	X	X	X	X	X	X	X
Hurricane Intensity	2													X			
Rainfall Rate/QPE	2								X	X	X	X			X	X	
Derived Stability Indices	2								X	X	X	X	X	X	X	X	X
Downward Solar Insolation Surf	2	X	X	X		X	X										
Reflected Solar Insolation TOA	2	X	X	X		X	X										
Fire Hot Spot Characterization	2		X					X							X	X	
Land Surface Temperature	2														X	X	
Snow Cover	2	X	X	X		X	X	X						X			
Sea Surface Temperature	2							X				X		X	X	X	
Volcanic Ash: Detection/Height	2										X	X			X	X	X



Way Forward

Outcomes from the Anomaly Teams this Fall:

- ✓ Provide recommendations on changes to GOES-T and GOES-U to address the Loop Heat Pipe issue
- ✓ Provide recommendations for the operation of GOES-17 to maximize mission performance
- ✓ Provide recommendations for the best constellation options for incorporating GOES-17, including potential changes to the operational usage of other assets (i.e. Himawari-8)

Notional Plan:

- ✓ Move GOES-17 to the GOES-West position in the Late Fall 2018
- ✓ Prepare to operate in tandem with GOES-15 for an extended period of time

GOES-17 Post-Launch Science Product Validation Schedule

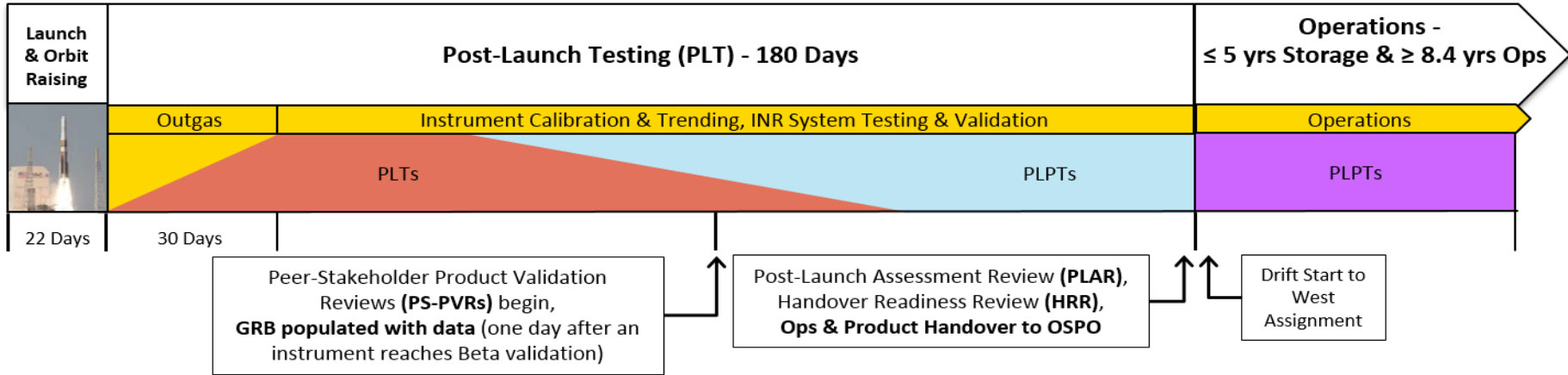

Sporadic data flow to support on-orbit anomaly testing

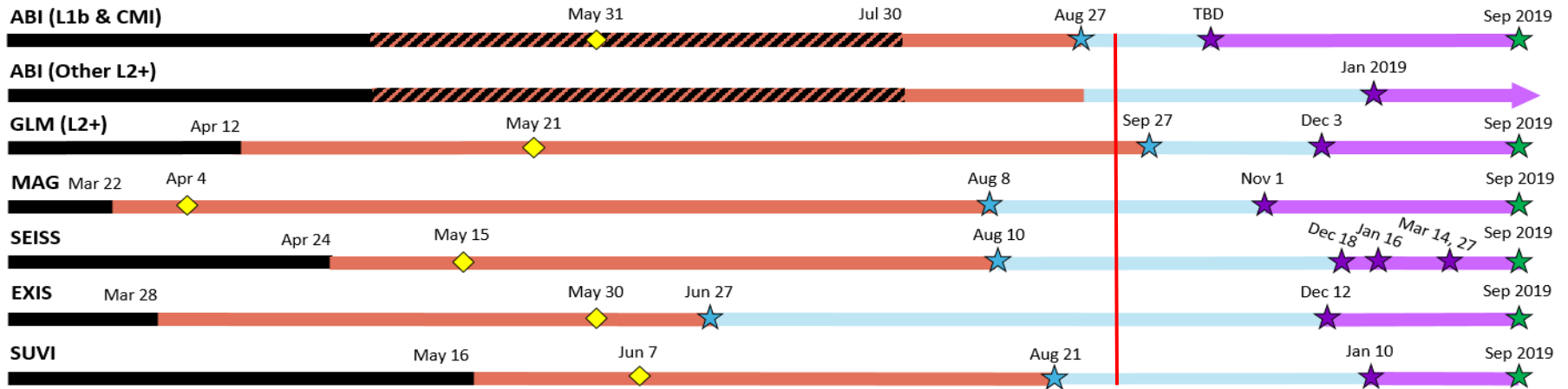

LEGEND

- Science Products Not Flowing
- Internal product flow begins
- Beta Validated Products: External product flow begins
- Provisionally Validated Products
- Fully Validated Products
- ◆ First public imagery media outreach
- ★ Beta PS-PVR
- ★ Provisional PS-PVR
- ★ Full Validation PS-PVR

Current as of August 26, 2018
elizabeth.kline@noaa.gov

Note: All dates are coordinated with Flight/MOST PLT SOE group and are subject to change.

HRIT/EMWIN User Group Broadcast Issues

-Product Duplication

-GOES-15 Image Identifiers

-Time Triggered Subscriptions

Seth Clevens

Broadcast Issues

•Product Duplications

–Problem

- Still experiencing duplicated datasets, though frequency is greatly reduced since database management update was incorporated into OPS in early summer

–Solution

- Fix is currently being tested/reviewed in PDA Integration and Testing environment
- Timeline TBD when it could be introduced to OPS due to other ongoing anomalous investigations

•GOES-15 Imager ID's in Segment Header

–Experienced a change after PDA Release 3.1 was introduced in August

- Image ID's are now not the same and increment for each of the 5 segments

–ESPDS Sustainment is looking into the issue and will address at a later time

- *GOES-15 imagery will not be provided to GOES-16, once GOES-17 transitions to GOES West*

Broadcast Issues

Known Time Triggered Meso Subscription Issues

•Problem

–Affects 3 Mesoscale Imagery products each 15 minutes from distributing

- Workaround was implemented on 5/8/2018 and seemed to work initially
- Maintenance conducted later on in the month reverted the change back
- Currently only 1 Mesoscale sector is uploaded for each band offering

•Solution

–Currently the patch to fix this problem is in the integration and test environment

–Expected to be deployed to OPS during PDA Release 3.2 (TBD)

Broadcast Issues

•GOES-R imagery provided to CBU's PDA

–Problem

- CBU PDA was never set up to ingest GOES-R series data
- HRIT/EMWIN has 3 of the 6 total broadcast stream services from CBU
- With 2 operational satellites, comes the need for at least 4 operational streams (a primary and backup for each satellite) that has a full product listing available for each satellite broadcast

–Resolution

- An automatic script pulling data directly from GOES-R Ground segment at NSOF, FTP's the data to be ingested at CBU. Would induce extra latencies for imagery for CBU PDA data streams.
 - NSOF PDA anomalies would not impact performance unless the VM that the script resides in is impacted

–Status

- Script was completed in August 2018, verification testing TBD
- Was planned to be tested and utilized during PLT

Broadcast Issues

• HRIT/EMWIN File Latency

–Problem

- Observed intermittent latency spikes in DCS data
- Affects other products as well

–Solution

- Separate HRIT/EMWIN “tailoring” from other PDA products to reduce high intermittent observed latency values

–Implementation Date

- The patch to address this issue is currently been validated in the integration and testing environment and slated to be deployed to OPS during the PDA Release 3.2.
 - Implementation date to OPS TBD

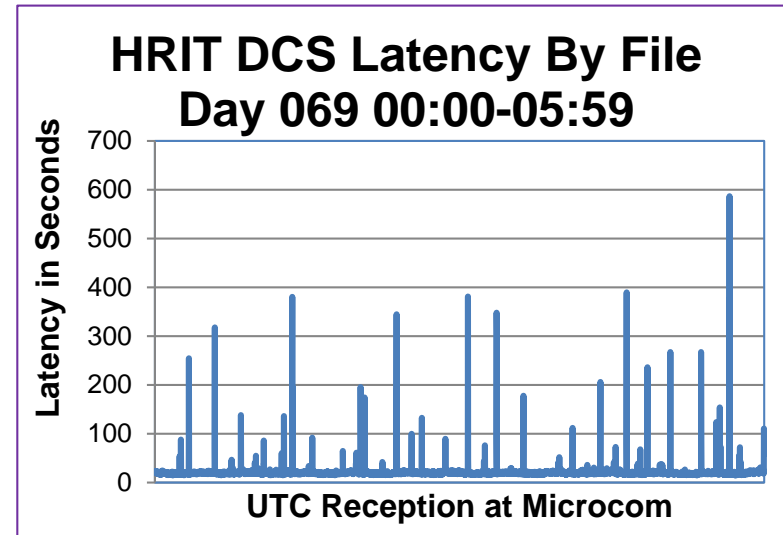

HRIT/EMWIN User Group Broadcast Issues

GOES-16 Imagery and Bandwidth Proposals

Seth Clevens

GOES-16 Imagery

Per FD
Image
per
Hour

Increasing the Frequency of Full Disk Images

- What's the problem?

- Bandwidth, HRIT/EMWIN has a 400 Kbps data relay capacity. To increase some bands would require decreasing other bands to offset.

- VCID 2 (Visual imagery) takes up 8.11% of hourly bandwidth during peak times (16-20Z) alone per image file

- Increasing the frequency would take up 1/3 of the hourly bandwidth and possibly induce latencies for other image files and ancillary products

- EMWIN and DCS together take up ~8% of hour bandwidth currently

- Leaving room for future product inclusion

- GOES-R Series Level 2+ products

- Other NWS products

VCID 2	8.11%
VCID 7	4.60%
VCID 8	2.47%
VCID 9	2.50%
VCID 13	4.29%
VCID 14	4.31%
VCID 15	4.15%

Future GOES-16 Imagery Selection

Possible Test Solutions?

- Designating Primary imagery bands and prioritizing based on availability
 - VCID's 2, 7 and 13 transmitted every 15 minutes OR
 - VCID's 7 and 13 transmitted every 15 minutes, VCID 2 remaining at 30 minutes
- Designating Secondary (less frequent) imagery bands
 - VCID's 8, 14, and 15 transmitted every 60 minutes and offset from each other
 - Adding VCID 17 for GOES West 4km LW IR Band 13 transmitted every 60 minutes
- Reducing products from outside of the satellite footprint
 - Himawari-8 imagery off of GOES East
 - NHC & NWS Pacific Tropical Discussions products off of GOES East
- Reducing the frequency of contingency imagery dissemination
- Removing redundant 2km Mesoscale bands (bands 7 and 13)

GOES East Test Stream #1 Peak Bandwidth

- VCID's 2, 7 and 13 increase frequency 15 minutes
- VCID's 8, 14 and 15 reduce frequency to once an hour (offset)
- VCID 9 (band 9 mid-level WV), H-8 and GOES-15 imagery is removed
- Redundant Mesoscale imagery bands 7 and 13 are removed
- GOES-17 4km Band 13 Full disk is added and distributed once a hour
- Add Level 2+ Products (TBD)

VCID	Description	Availability	18z Peak %
VCID 0	Admin Text	60 minutes	0.00%
VCID 1	Mesoscale Band 2 both scenes	15 minutes	5.00%
VCID 2	2km Visual Band 2	15 minutes	32.98%
VCID 7	2km SW IR Band 7	15 minutes	18.79%
VCID 8	2km WV Band 8	60 minutes	2.48%
VCID 13	2km Clean LW IR Band 13	15 minutes	20.07%
VCID 14	2km LW IR Band 14	60 minutes	4.34%
VCID 15	2km Dirty LW IR Band 15	60 minutes	4.16%
VCID 17	4km Clean LW IR Band 17 from GOES West	60 minutes	2.50%
VCID 20	EMWIN Priority 1 and 2	On Arrival	0.62%
VCID 21	EMWIN Graphics	On Arrival	0.00%
VCID 22	EMWIN Priority 3 and 4	On Arrival	3.42%
VCID 23	NWS Data	On Arrival	0.01%
VCID 24	NHC Data	On Arrival	0.12%
VCID 25	Level 2+ Products	Varies w/ Subscription	1.63%
VCID 31	DCS Data	On Arrival	3.95%
Total			100.07%

GOES East Test Stream #2 Peak Bandwidth

- VCID's 2, 7 and 13 increase frequency 15 minutes
- VCID's 8 and 14 reduce frequency to once an hour (offset)
- VCID 9 (band 9 mid-level WV) and 15 (band 15 Dirty LW IR) is removed
- Himawari-8 and GOES-15 are removed
- GOES-17 4km Band 13 Full disk is added and distributed once a hour
- Add Level 2+ Products (TBD)

VCID	Description	Availability	18z Peak %
VCID 0	Admin Text	60 minutes	0.00%
VCID 1	Mesoscale Band 2 both scenes	15 minutes	5.00%
VCID 2	2km Visual Band 2	15 minutes	32.98%
VCID 7	2km SW IR Band 7	15 minutes	18.79%
VCID 8	2km WV Band 8	60 minutes	2.48%
VCID 13	2km Clean LW IR Band 13	15 minutes	20.07%
VCID 14	2km LW IR Band 14	60 minutes	4.34%
VCID 17	4km Clean LW IR Band 17 from GOES West	60 minutes	2.50%
VCID 20	EMWIN Priority 1 and 2	On Arrival	0.62%
VCID 21	EMWIN Graphics	On Arrival	0.00%
VCID 22	EMWIN Priority 3 and 4	On Arrival	3.42%
VCID 23	NWS Data	On Arrival	0.01%
VCID 24	NHC Data	On Arrival	0.12%
VCID 25	Level 2+ Products	Varies w/ Subscription	1.50%
VCID 31	DCS Data	On Arrival	3.95%
Total			93.46%

GOES East Test Stream #3 Peak Bandwidth

- VCID's 7 and 13 increase frequency to 15 minutes
- VCID 2 at 30 minutes distribution
- VCID's 8, 14 and 15 reduce frequency to once an hour (offset)
- VCID 9 (band 9 mid-level WV), H-8 and GOES-15 imagery is removed
- Redundant Mesoscale imagery bands 7 and 13 are removed
- GOES-17 4km Band 13 Full disk is added and distributed once a hour
- Add Level 2+ Products (TBD)

VCID	Description	Availability	18z Peak %
VCID 0	Admin Text	60 minutes	0.00%
VCID 1	Mesoscale Band 2 both scenes	15 minutes	5.00%
VCID 2	2km Visual Band 2	30 minutes	16.49%
VCID 7	2km SW IR Band 7	15 minutes	18.79%
VCID 8	2km WV Band 8	30 minutes	4.96%
VCID 13	2km Clean LW IR Band 13	15 minutes	20.07%
VCID 14	2km LW IR Band 14	30 minutes	8.68%
VCID 15	2km Dirty LW IR Band 15	30 minutes	8.32%
VCID 17	4km Clean LW IR Band 17 from GOES West	60 minutes	2.50%
VCID 20	EMWIN Priority 1 and 2	On Arrival	0.62%
VCID 21	EMWIN Graphics	On Arrival	0.00%
VCID 22	EMWIN Priority 3 and 4	On Arrival	3.42%
VCID 23	NWS Data	On Arrival	0.01%
VCID 24	NHC Data	On Arrival	0.12%
VCID 25	Level 2+ Products	Varies w/ Subscription	1.63%
VCID 31	DCS Data	On Arrival	3.95%
Total			94.56%

GOES East Test Stream #4 Peak Bandwidth

- All Imagery VCID's frequency distribution stay the same (nominal 30 minutes)
- Himawari-8 and GOES-15 are removed
- GOES-17 4km Band 13 Full disk is added and distributed twice an hour
- Add Level 2+ Products (TBD)
- Leaves plenty of room for other product additions (ie GLM) and times of heightened bandwidth usage

VCID	Description	Availability	18z Peak %
VCID 0	Admin Text	60 minutes	0.00%
VCID 1	Mesoscale Band 2 both scenes	15 minutes	5.00%
VCID 2	2km Visual Band 2	30 minutes	16.49%
VCID 7	2km SW IR Band 7	30 minutes	9.40%
VCID 8	2km WV Band 8	30 minutes	4.96%
VCID 9	2km WV Band 9	30 minutes	5.00%
VCID 13	2km Clean LW IR Band 13	30 minutes	10.04%
VCID 14	2km LW IR Band 14	30 minutes	8.68%
VCID 15	2km Dirty LW IR Band 15	30 minutes	8.32%
VCID 17	4km Clean LW IR Band 17 from GOES West	30 minutes	5.00%
VCID 20	EMWIN Priority 1 and 2	On Arrival	0.62%
VCID 21	EMWIN Graphics	On Arrival	0.00%
VCID 22	EMWIN Priority 3 and 4	On Arrival	3.42%
VCID 23	NWS Data	On Arrival	0.01%
VCID 24	NHC Data	On Arrival	0.12%
VCID 25	Level 2+ Products	Varies w/ Subscription	1.63%
VCID 31	DCS Data	On Arrival	3.95%
Total			82.63%

HRIT/EMWIN User Group

-Level 2+ Product Inclusion Details

-DCS File Format Change

Seth Clevensine

Level II Baseline Products Summary

- There are 25 Baseline Level II ABI Products
 - See the list at: <https://www.goes-r.gov/products/baseline.html>
- HRIT has a selection of ABI with no plans to add Radiances
- Several products are not viable due to size, bandwidth limitations and seasonal availability
 - Derived Motion Winds
 - Vertical Temperature & Moisture Profile
 - Snow Cover
 - GLM in it's current state within PDA
 - Hurricane Intensity Estimation

Level 2+ Product Development

Listing of Products Currently in HRIT Development

~~Volcanic Ash: Detection and Height~~

~~Cloud Optical Depth~~

~~Cloud Particle Size Distribution~~

~~Cloud Top Phase~~

~~Cloud Top Pressure~~

~~Cloud Top Temperature~~

~~Hurricane Intensity Estimation~~

~~Rainfall Rate / QPE~~

~~Fire/Hot Spot Characterization~~

~~Land Surface Temperature (Skin)~~

~~Snow Cover~~

~~Sea Surface Temperature (Skin)~~

~~Total Precipitable Water~~

~~Derived Stability Indices~~

~~Legacy Vertical Moisture Profile (Quite large)~~

~~Legacy Vertical Temperature Profile (Quite~~

~~large)~~

~~Aerosol Detection (Including Smoke and Dust)~~

~~Aerosol Optical Depth (AOD)~~

~~Clear Sky Masks~~

~~Cloud Top Height~~

~~Derived Stability Indices~~

~~Downward Shortwave Radiation: Surface~~

~~Reflected Shortwave Radiation~~

Development Level 2+ Product Bandwidth Sizes

Level II Product Description	Total Files per Day	Possible File Availability to HRIT	Average Size per file (kb)	Hourly Bandwidth %
Derived Stability Indices (CAPE/LI)	96	60 minutes	4359.90	0.30%
Fire/Hot Spot Characterization	96	4 hours	24895.30	1.73%
Land Surface Temperature	24	60 minutes	3007.18	0.21%
Rain Rate / QPE Full Disk	96	60 minutes	11861.88	0.82%
Sea Surface Temperature	24	12 hours	49658.93	3.45%
Total Precipitable Water	96	60 minutes	4329.21	0.30%
Cloud Top Height	96	4 hours	93899.50	6.52%

- Due to bandwidth limitations, products listed in red, the frequency of distribution would have to be decreased and offset from distributing to the broadcast during peak hours (16-20z daily)
- Level 2+ products alone would work with current broadcast configuration (imagery every 30 min) if offset to imagery non-distributing times
- Hourly bandwidth statistics are averaged above and vary
- Would require a low priority on the broadcast with the possibility of being purged from dissemination due to bandwidth restrictions being reached

Proposed Future HRIT/EMWIN Work

- DCS File Format Proposal by Microcom

- Proposal is to change the header information on each message within DADDS, nothing changed on the .lrit file. Current protocol is outdated and inefficient

- Affects the HRIT software reception that parses DCS data messages

- Would need HRIT/EMWIN manufacturers input on this specific DCS change and what it means to their clients reception

- Proposal is to have a transition period (3-6 months) over the GOES East broadcast where DCS bandwidth would double in size by streaming both the old and new version simultaneously.

- DCS bandwidth % is currently ~3.7, this would increase it to 8% of the broadcast.

- No defined timeframe yet when it will be implemented

GOES East Summary of Proposals

- Current 30 minute Imagery schedule will allow for additional level 2+ products and new DCS file format addition. Best option current without losing anything already provided.
- Any increase in Band 2 Full Disk imagery will have to be offset by losing frequency of other full disk products
- Any increase modification to imagery frequency will decrease the amount of Level 2+ products available to HRIT
- The need to account for 3-6 months of doubled DCS data to allow DCS users time to change software on receivers
- GOES-15 and Himawari-8 data will not be available on GOES East past GOES West transition. Changes will occur simultaneously.

GOES West Summary of Proposals

–Any proposal for modifications to GOES East’s

HRIT/EMWIN broadcast stream configuration will be matched with GOES West’s broadcast, except the following:

- GOES-16 4km resolution Band 13 (LW IR) will added for contingency
- Himawari-8 imagery will be added
- Pacific region NHC products will be added
- Atlantic region NHC products will be removed
- ABI Level 2+ products that aren’t provisionally validated and available through PDA

Post Launch GOES-17 HRIT/EMWIN Test

- Scheduled this week from the 10th through the 14th at 1400z.
- Due to Critical Weather Declaration from NOAA, unable to adequately test different PDA to acquisition site configurations
 1. NSOF PDA to Wallops Command Data and Acquisition Site (WCDAS)
 - ~~2. NSOF PDA to Consolidated Backup (CBU) acquisition site~~
 - ~~3. CBU PDA to CBU acquisition site~~
 - ~~4. CBU PDA to WCDAS~~
- Successfully tested various G16 imagery stream configurations
 - Main emphasis of testing was getting data on performance and bandwidth statistics
- Planning to reschedule CBU PDA testing next week for comparison testing
- Any end user feedback from GOES-17 PLT regarding broadcast reception and product inclusion is welcome, a big thank you to all that participated.

HRIT/EMWIN User Group - 9/13/2018
EMWIN Update

Emergency Managers Weather Information Network (EMWIN)

EMWIN Program Manger:	Bob Gillespie	robert.gillespie@noaa.gov	(301) 427-9693
Chief Dissemination Systems:	Craig Hodan	craig.hodan@noaa.gov	(301) 427-9678
EMWIN Support eMail Contact:		nws.emwin.support@noaa.gov	

NWS HRIT/EMWIN Deployment Status:

1. NWS Data Center Build Out - COMPLETE

College Park, MD

Boulder, CO

2. Network Infrastructure and NESDIS PDA Interface – COMPLETE

NSOF, Suitland, MD

CBU, Fairmont, WV

3. EMWIN Processing Software : IN PROGRESS

- software rework to correct deficiencies is in progress

- planned operational date: October 2018 (slipped from July 2018)

4. NWS/NESDIS 24x7 Operational Support Services – READY

... to start with 30-day Software Acceptance Test (June 2018); and available thereafter.

EMWIN Broadcast / GOES Satellite Constellation

1. GOES-East (GOES-16) @ 75.2° W

- a) HRIT/EMWIN Transmitter active (Dec 2018 ...)
- b) EMWIN sub-channels (20,21,22) for testing only – NWS will announce “operational use”.

2. GOES-14 @ 105° W

- a) EMWIN Transmitter active (thru on or about November 15th 2018).
- b) EMWIN receivers remain in use; awaiting NWS clearance of GOES-16 EMWIN channels

3. GOES-West (GOES-15) @ 135° W

- a) EMWIN Transmitter active (Dec 2011 thru on or about November 15th 2018).

4. GOES-17 @ 89.5° W (temporary checkout position)

- a) HRIT/EMWIN Transmitter active – with content.
- b) Satellite to drift to 137° W; will become operational late 2018

EMWIN Update

EMWIN Sub-Channels:

1. Channel 20 - "Priority"

- a) Text (.txt / .zip)
- b) EMWIN priority 1 & 2 text products, including Warnings and Alerts

2. Channel 21 – "Graphics"

- a) Binary (.gif .png .jpg / .zip)
- b) http://www.nws.noaa.gov/emwin/EMWIN_Image_and_Text_Data_Capture_Catalog_v1.3_r180817.pdf

3. Channel 22 – "Other"

- a) Text (.txt / .zip)
- b) EMWIN priority 3 and 4 text products, Observations, Forecasts and Climate

HRIT/EMWIN Virtual Channel ID	Group	Product Name
0	Imagery	Admin Text Messages
1	Imagery	Mesoscale 1km (ch. 2, 7, 13)
2	Imagery	Band 2 - Red
3	Imagery	GOES-13 IR
6	Imagery	GOES-15 IR
7	Imagery	Band 7 - Shortwave Window
8	Imagery	Band 8
9	Imagery	Band 9 - Mid-Level Trop
13	Imagery	band 13
14	Imagery	Band 14 - IR
15	Imagery	Band 15
20	EMWIN	Priority
21	EMWIN	Graphics
22	EMWIN	Other
23	Imagery	NWS Products
24	Imagery	NHC Graphics Products
25	Imagery	GOES-R JPG Products
26	Imagery	International Graphics Products
30	DCS	DCS Admin
31	DCS	DCS Data
60	Imagery	Himawari

EMWIN Product Characteristics on HRIT/EMWIN

Broadcast:

1. Product sources:

- a) US NOAA Weather Wire Service (NWS) – subset
- b) RTH/GISC Washington GTS Switch (International Products)
- c) Internet/Web (Hurricane, Radar, Satellite Images)

2. File format

- a) Full contiguous file
- b) Longer file names

ref: http://www.nws.noaa.gov/emwin/EMWIN_GOES-R_filename_convention.pdf

3. Additional information available on NWS EMWIN Web Page:

<http://www.nws.noaa.gov/emwin/index.html#issues>

EMWIN Update

HRIT/EMWIN Full Service Receiving Station Manufacturers:

1. **Dartcom Systems Ltd.**, Powdermills, Postbridge, Yelverton, Devon, UK. , POC: David Wright, dave@dartcom.co.uk, +44 1822 88025
http://www.nws.noaa.gov/emwin/pdf/HRIT-EMWIN_Configuration_Documentation_Form_r180214-1320%20Dartcom%20Systems%20Ltd.pdf

HRIT/EMWIN Compatible Receiver Manufacturers:

1. **Global Imaging, Inc.**, 3228 N. Twin Oaks Valley Road Unit A, San Marcos, CA 92069, POC: Steven Borders sborders@globalimaging.com Ph: (858) 481-5750
2. **Global – LG (Dartcom USA sales)**, 426 Jolina Way, Encinitas, CA 92024, POC - Michael Guberek michael.guberek@global-lg.com Ph: (619) 301- 0421
3. **Microcom Design, Inc.**, 10948 Beaver Dam Road, Hunt Valley, MD, USA 21030, POC - Brett Betsill, Perry West, bbetsill@microcomdesign.com pwest@microcomdesign.com Tel: (410) 771-1070
4. **Quorum Communications, Inc.**, 3807 Carbon Rd. Irving, TX 75038-3415, POC - Allan Bundens, allan.b@qcom.com Ph: (800) 982-9614

Pacific Region HRIT/EMWIN Receiving Station Development & Configuration Activity

This listing does not imply any particular product or service endorsement or recommendation by the NWS. Customers should consult the vendors to determine product suitability for the customers' specific need and environment.

ESPC Notifications, Status, and Contacts

Subscribe to ESPC for notifications. This is the primary way for you to receive notifications and information on GOES status and schedules!

24/7 Help Desk	ESPCOperations@noaa.gov
ESPC Messages	http://www.ssd.noaa.gov/PS/SATS/messages.html
User Services	SPSD.UserServices@noaa.gov
Data Access	NESDIS.Data.Access@noaa.gov
Facebook	www.facebook.com/NOAANESDIS
Twitter	www.twitter.com/noaasatellites
Press releases	http://www.nesdis.noaa.gov/news_archives/
GOES Status	http://www.ospo.noaa.gov/Operations/GOES/status.html
GOES User Information and Documents	http://www.ospo.noaa.gov/Operations/GOES/documents.html
POES Schedules	http://www.ospo.noaa.gov/Operations/GOES/schedules.html

HRIT/EMWIN User Configuration Info

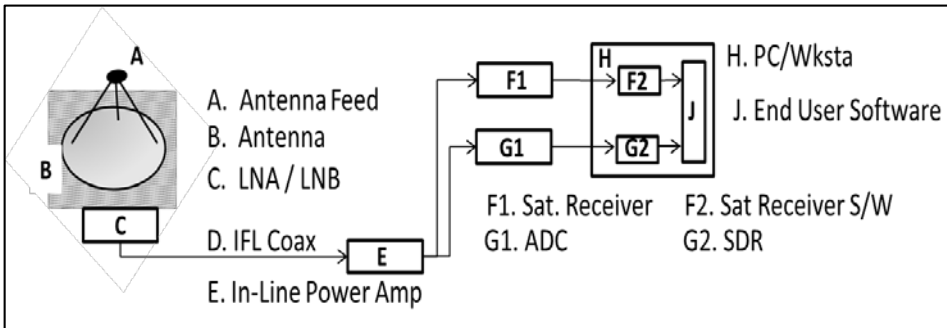

- NOAA is looking for end user feedback on the many different configurations that's being used for current HRIT/EMWIN broadcast receipt.
- Strictly voluntarily to help support other users
- Configurations will be posted on EMWIN and NOAASIS webpages for public view
 - Personal identifiable information will not be obtained, just the configuration information.

<u>A. Antenna Feed:</u> Mfg – Model – P/N –	<u>F1. Satellite Receiver:</u> Mfg – Model – P/N –
<u>B. Antenna:</u> Mfg – Model – P/N –	<u>F2. Satellite Receiver Software:</u> Mfg – Name – Release –
<u>C. LNA / LNB:</u> Mfg – Model – P/N –	<u>G1. SDR Analog/Digital Converter:</u> Mfg – Model – P/N –
<u>D. IFL Coax Cable:</u> Mfg – Item No – Length –	<u>G2. Software Defined Radio:</u> Mfg – Name – Release –
<u>E. In-Line Power Amp:</u> Mfg – Model – P/N –	<u>H. PC/Workstation</u> Mfg – Model – P/N – O/S Mfg – O/S Name – O/S Release –

HRIT/EMWIN Broadcast Contact Information

Seth Clevenstine

HRIT/EMWIN Program Manager

Direct Services Branch

Satellite Products and Services Division

Office of Satellite and Product Operations

NOAA NESDIS

NOAA Satellite Operations Facility (NSOF) Suitland, MD

Cubicle #1653

Email: seth.clevenstine@noaa.gov

Tel: 301-817-4558

NWS EMWIN Product Contact Information

Robert Gillespie

EMWIN Program Manager

National Weather Service Office of Dissemination

NOAA NWS

1325 East West Highway

Silver Spring, MD 20910

Email: Robert.Gillespie@noaa.gov

Tel: 301-427-9693

HRIT/EMWIN User Group

Next meeting will be Early December

Thanks for your participation!

HRIT/EMWIN User Group

Open Discussion

Seth Clevestine

HRIT/EMWIN User Group

Wrap-Up/Summary

Paul Seymour

HRIT/EMWIN User Group

Back-up Slides

Production and Uplink Systems

Characteristic	HRIT/EMWIN System Configuration
Input Streams All Go Through the Product Dissemination & Access (PDA) Systems	<ol style="list-style-type: none"> 1. Imagery – PDA NSOF, Suitland, MD or CBU Fairmont, WV 2. EMWIN – NWS “Gateway” College Park, MD or Boulder, CO 3. DCS – DADDS NSOF, Suitland, MD or DADDS Wallops, VA 4. NHC Products – Acquired over the internet at this time
PDA / HRIT-EMWIN Broadcast Stream Production	<p><u>Primary</u> – Satellite Operations Facility (NSOF) in Suitland, MD</p> <p><u>Backup</u> – Consolidated Backup Facility (CBU) in Fairmont, WV</p> <ul style="list-style-type: none"> • Both can feed uplink antenna systems at Wallops, WV and the CBU
Uplink Antenna Systems	<p><u>Primary</u> – Command & Data Acquisition Station (WCDAS) Wallops Island, VA</p> <p><u>Backup</u> – Consolidated Backup Facility (CBU) in Fairmont, WV</p> <ul style="list-style-type: none"> • Both can uplink HRIT/EMWIN to GOES-R Series Satellites
Downlink and Data Monitoring	<ul style="list-style-type: none"> • Front End Processors (FEPS) linked to GOES-R antennas at WCDAS/CBU have both transmit and receive capability. Received files are relayed back to PDA’s for transmit-receipt & checksum validation • Anomaly warning messages are generated to help desk & operators • VSAT stations are online at the NSOF for troubleshooting
User Input on Broadcast Quality	<p><u>Input from users/manufacturers in the field is highly desired</u></p>

PDA to HRIT to Acquisition Site Data Flow

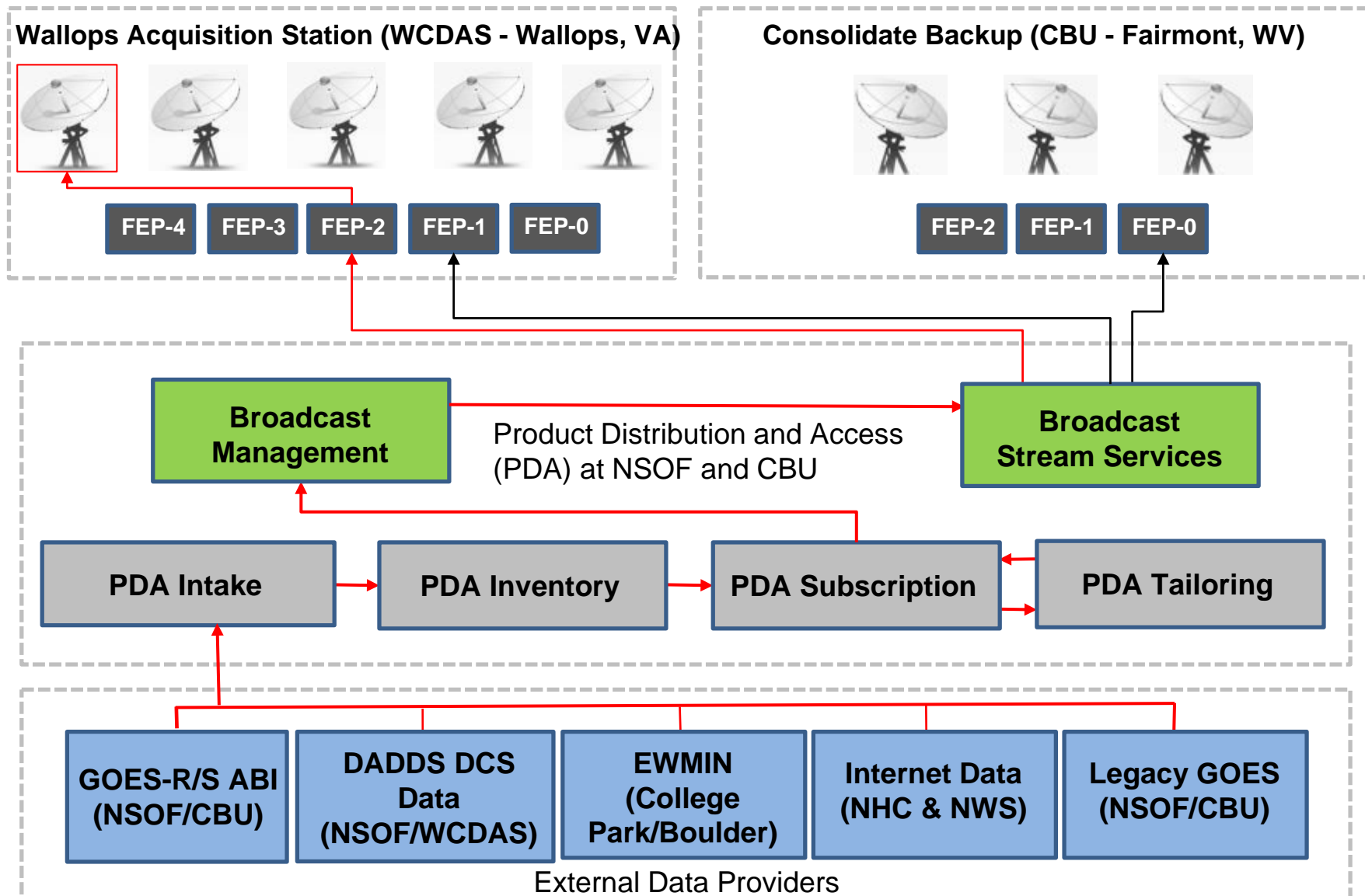

Organization of the Broadcast Stream

- Three “Broadcast Groups”: Imagery, EMWIN, DCS
 - Prioritized:
 - #1 - EMWIN: All EMWIN products on VCID 20, 21 and 22
 - #2 – DCS: All DCS products on VCID 30 & 31
 - #3 – Imagery: Includes all GOES East, West and H-8 on VCID’s 1-15 and 60.
 - Each Group has a guaranteed and maximum bandwidth allocated

Group Name	Guaranteed Bandwidth	Maximum Bandwidth	Group Order Rank
EMWIN	8%	15%	1
DCS	5%	10%	2
Imagery	72%	100%	3

Broadcast Stream Configurations

- Users of the PDA and HRIT/EMWIN use “Subscriptions”
 - As data arrives in the PDA, it is made available to HRIT / EMWIN “subscriptions” then becoming available for the “broadcast streams”
- There can be multiple broadcast streams with different product combinations
- Nominal East and West Streams will be the baseline
 - Full disk of 7 ABI bands and Mesoscale images in 3 bands
 - Full disk of Himawari in 3 bands on GOES-West
 - EMWIN, DCS observations, NHC information
- Other streams could be available; e.g. Super Tropical Storm
 - After they are set up, broadcast streams can be changed “on the fly”

GOES HRIT/EMWIN Operations

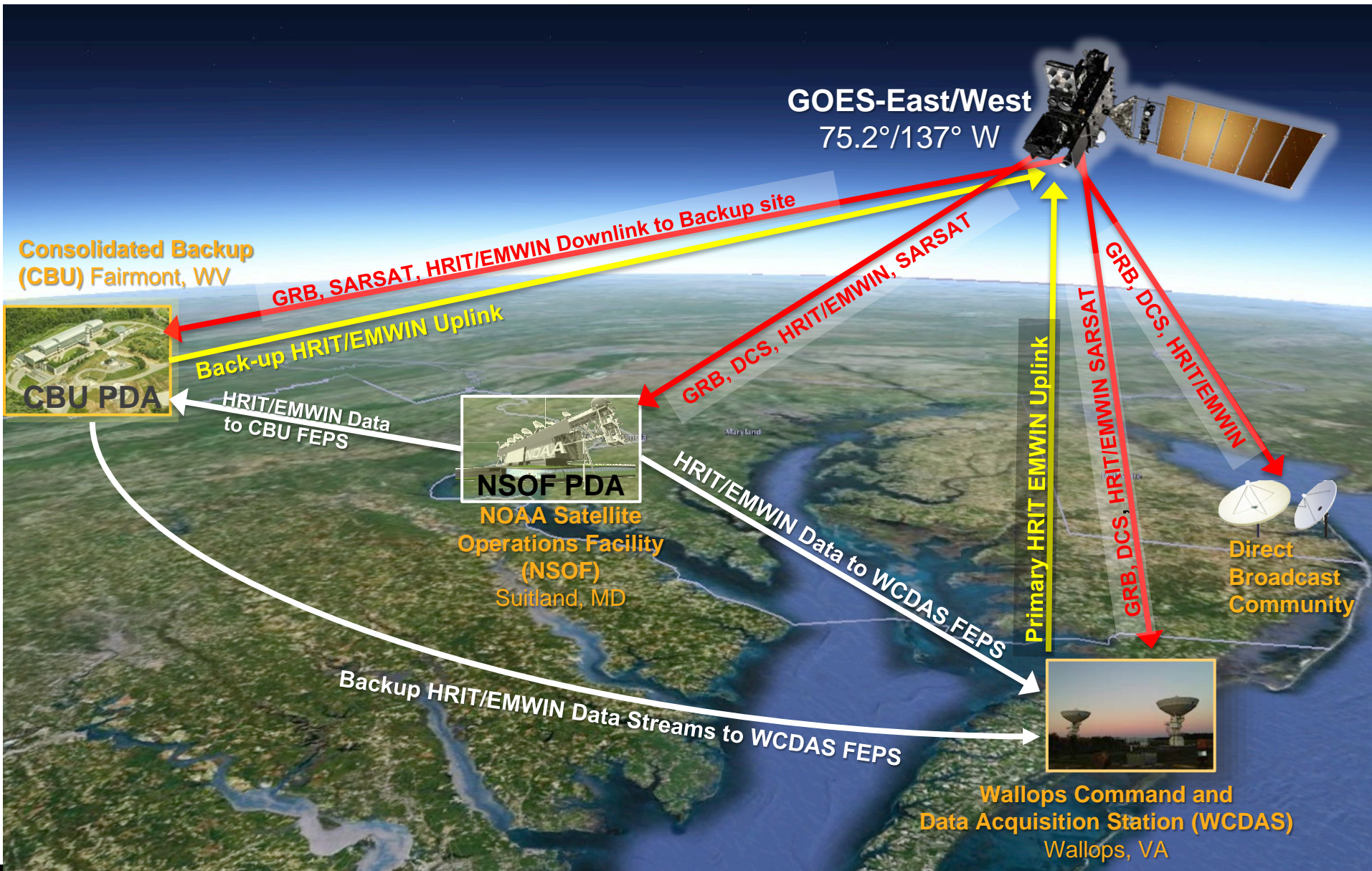

Current GOES East VCID Selection

VCID #	Product Name	Period -Min	Format	Source Link
0	Admin Text	60	Text Messages	N/A
1	Mesoscale 1 Km box (Bands 2, 7, 13)	15	HRIT/LRIT	https://www.goes-r.gov/spacesegment/abi.html
2	CMI Band 2	30	HRIT/LRIT	https://www.goes-r.gov/education/ABI-bands-quick-info.html
6	GOES-15 IR FD and NH	30	LRIT	http://www.goes.noaa.gov/goesfull.html
7	CMI Band 7	30	HRIT/LRIT	https://www.goes-r.gov/education/ABI-bands-quick-info.html
8	CMI Band 8	30	HRIT/LRIT	https://www.goes-r.gov/education/ABI-bands-quick-info.html
9	CMI Band 9	30	HRIT/LRIT	https://www.goes-r.gov/education/ABI-bands-quick-info.html
13	CMI Band 13	30	HRIT/LRIT	https://www.goes-r.gov/education/ABI-bands-quick-info.html
14	CMI Band 14	30	HRIT/LRIT	https://www.goes-r.gov/education/ABI-bands-quick-info.html
15	CMI Band 15	30	HRIT/LRIT	https://www.goes-r.gov/education/ABI-bands-quick-info.html
20	EMWIN - Priority	Variable	Text	http://www.nws.noaa.gov/emwin/EMWIN_Image_and_Text_Data_Capture_Catalog_table_v1.1_r171002_1350.pdf
21	EMWIN - Graphics	Variable	Graphic (e.g. GIF, JPEG)	http://www.nws.noaa.gov/emwin/EMWIN_Image_and_Text_Data_Capture_Catalog_table_v1.1_r171002_1350.pdf
22	EMWIN - Other	Variable	Text and Graphic	http://www.nws.noaa.gov/emwin/EMWIN_Image_and_Text_Data_Capture_Catalog_table_v1.1_r171002_1350.pdf
23	NWS Products	60	Graphic	http://tgftp.nws.noaa.gov/data/hurricane_products/
24	NHC Graphics Products	60	Graphic (e.g. GIF, JPEG)	http://www.nhc.noaa.gov/tafb_latest/
25	GOES-R JPEG Products	None At This Time	JPEG	http://www.ospo.noaa.gov/Products/imagery/index.html
26	Int'l Graphics Products	60	Graphic (e.g. GIF, JPEG)	http://www.ospo.noaa.gov/Products/imagery/index.html
30	DCS Admin	Continual	Text	https://dcs1.noaa.gov/Account/Login
31	DCS Data	Continual	Formatted Text	https://dcs1.noaa.gov/Account/Login
60	Himawari	60	LRIT	http://www.data.jma.go.jp/mscweb/data/himawari/index.html

Receive System Components - General

Component	HRIT/EMWIN Broadcast Specifications	Additional Information
Platform	Operational East and West GOES-R Series Satellites	<ul style="list-style-type: none"> • GOES-16 at 75.2 West • GOES-17 at 137.0 West <ul style="list-style-type: none"> ○ Launched March 1, 2018 ○ Predicted Operational West Fall 2018
Broadcast	Operating Frequency Range	L-band
	Center Frequency	1694.1 MHz
	Data Rate	400 Kbps
	Symbol Rate	927 ksps
	Modulation - BPSK	<ul style="list-style-type: none"> • Convolutional rate ½ code with constraint length 7 concatenated with Reed Solomon (255,223) with Interleave = 4 • Square Root Raised Cosine filtering using an Alpha factor of 0.3 • The resulting “Necessary Bandwidth” for this signal will be 1.205 MHz
	Polarization - Linear	Vertical Offset
Antenna System	VSAT	<ul style="list-style-type: none"> • At 5 degree elevation, the minimum antenna is 1.2 meter. • At 10 degrees or more elevation the minimum size is 1.0 meter
Low-Noise Block-Down Converter	L-band	Example: <ul style="list-style-type: none"> • Input 1691 MHz • Output 137.5 Mhz
Satellite Receiver	L-band	<ul style="list-style-type: none"> • BPSK 1691MHz to 137.5MHz
Software	N/A	<ul style="list-style-type: none"> • De-encapsulates HRIT/LRIT files • Visualization and Manipulation of Files • Optional Applications (examples) <ul style="list-style-type: none"> ○ EMWIN visualization application ○ GOES-DCS database software or application

GOES-16 Imagery Schedule

GOES-East ABI Flex Mode (Routine) Schedule - Abridged

MESO 1 and MESO 2 frames will each be imaged once every minute at the following times:

MESO 1 - XX:XX:24.4 - 5.6 sec dur

MESO 2 - XX:XX:54.4 - 5.6 sec dur

Full Disk on HRIT/EMWIN every 30 min in 7 ABI bands. The table below shows a 15 minute schedule with HRIT product pulls in bold. XX = Hour.

 TIME (UTC) SCAN SECTOR DURATION (MM:SS)

XX:00:24	MESO 1	5.6 sec
XX:00:35	Full Disk	10:37
XX:00:54	MESO 2	5.6 sec
XX:01:24	MESO 1	5.6 sec
XX:01:54	MESO 2	5.6 sec
XX:02:16	CONUS	02:37
XX:02:24	MESO 1	5.6 sec
XX:02:54	MESO 2	5.6 sec
XX:03:24	MESO 1	5.6 sec
XX:03:54	MESO 2	5.6 sec
XX:04:24	MESO 1	5.6 sec
XX:04:54	MESO 2	5.6 sec

XX:05:24	MESO 1	5.6 sec
XX:05:54	MESO 2	5.6 sec
XX:06:24	MESO 1	5.6 sec
XX:06:54	MESO 2	5.6 sec
XX:07:16	CONUS	02:37
XX:07:24	MESO 1	5.6 sec
XX:07:54	MESO 2	5.6 sec
XX:08:24	MESO 1	5.6 sec
XX:08:54	MESO 2	5.6 sec
XX:09:24	MESO 1	5.6 sec
XX:09:54	MESO 2	5.6 sec
XX:10:24	MESO 1	5.6 sec
XX:10:54	MESO 2	5.6 sec
XX:11:24	MESO 1	5.6 sec
XX:11:54	MESO 2	5.6 sec
XX:12:16	CONUS	02:37
XX:12:24	MESO 1	5.6 sec
XX:12:54	MESO 2	5.6 sec
XX:13:24	MESO 1	5.6 sec
XX:13:54	MESO 2	5.6 sec
XX:14:24	MESO 1	5.6 sec
XX:14:54	MESO 2	5.6 sec
XX:15:24	MESO 1	5.6 sec
XX:15:35	Full Disk	10:37
XX:15:54	MESO 2	5.6 sec

Products Received During the Hour

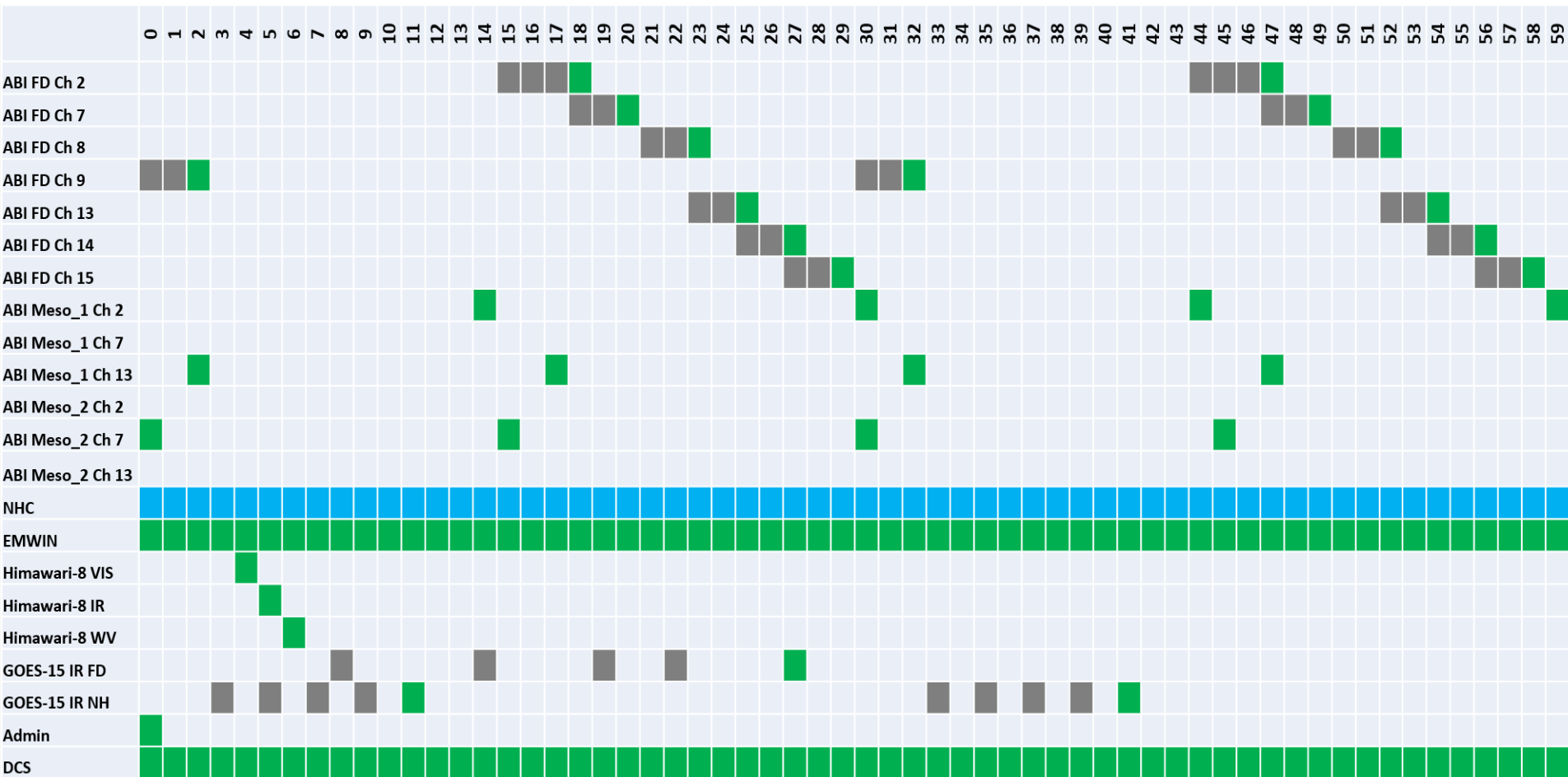

■ Full Product Completion
 ■ Product Segment Start
 ■ Product Varies

